

# MDE Semiconductor, Inc.

201 Shipyard Way, Unit C, Newport Beach, CA., USA 92663 Tel : 760-564-8656 • Fax : 760-564-2414  
1-800-831-4881 Email: sales@mdesemiconductor.com Web: www.mdesemiconductor.com

## P6KE SERIES

### GLASS PASSIVATED JUNCTION TRANSIENT VOLTAGE SUPPRESSOR VOLTAGE - 6.8 TO 550 Volts 600 Watt Peak Power 5.0 Watt Steady State

#### FEATURES

- Plastic package has Underwriters Laboratory Flammability Classification 94 V-0
- Glass passivated chip junction in DO-15 (DO-204AC) package
- 600W surge capability at 10/1000  $\mu$ s
- Low zenen impedance
- Excellent clamping capability
- Fast response time: typically less than 1.0 ps from 0 volts to BV min.
- Typical IR less than 1 $\mu$ A above 10V
- High temperature soldering guaranteed: 265°C/10 seconds/ .375", (9.5mm) lead length, 5lbs., (2.3kg) tension

#### MECHANICAL DATA

Case: JEDEC DO-15 Molded plastic  
 Terminals: Plated Axial leads, solderable per MIL-STD-750, Method 2026  
 Polarity: Color band denoted positive end (cathode) except Bipolar  
 Mounting Position: Any  
 Weight: 0.015 ounces, 0.4 grams

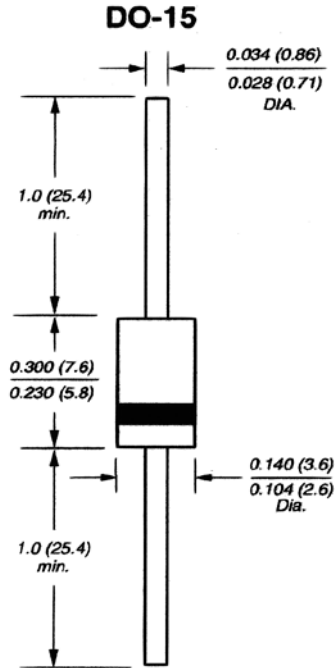

*Dimensions in inches and (millimeters)*

#### DEVICES FOR BIPOLAR APPLICATIONS

For Bidirectional use C or CA Suffix for types P6KE6.80 thru types P6KE550 (e.g. P6KE6.8C, P6KE550CA)  
 Electrical characteristics apply in both directions.

#### MAXIMUM RATINGS AND CHARACTERISTICS

Ratings at 25°C ambient temperature unless otherwise specified.

RATING	SYMBOL	VALUE	UNITS
Peak Pulse Power Dissipation at TA = 25 °C, TP = 1ms (NOTE 1)	$P_{PPM}$	Minimum 600	Watts
Peak Pulse Current of on 10/1000 $\mu$ s waveform (Note 1)	$I_{PPM}$	SEE TABLE 1	Amps
Steady State Power Dissipation at TL = 75°C Lead lengths .375", 9.5mm (Note 2)	$P_{M(AV)}$	1.0	Watts
Peak Forward Surge Current, 8.3ms Single Half Sine-wave Superimposed on Rated Load, (JEDEC Method)(Note 3)	$I_{FSM}$	100	Amps
Operatings and Storage Temperature Range	$T_J, T_{STG}$	-55 +175	°C

**NOTES:**

1. Non-repetitive current pulse, per Fig.3 and derated above Ta=25 °C per Fig.2.
2. Mounted on Copper Pad area of 1.6x1.6" (40x40mm) per Fig.5.
3. 8.3ms single half sine-wave, or equivalent square wave, Duty cycle=4 pulses per minutes maximum.

Certified RoHS Compliant

UL File # E223026

# MDE Semiconductor, Inc.

201 Shipyard Way, Unit C, Newport Beach, CA., USA 92663 Tel : 760-564-8656 • Fax : 760-564-2414  
 1-800-831-4881 Email: sales@mdesemiconductor.com Web: www.mdesemiconductor.com

## RATING AND CHARACTERISTIC CURVES P6KE SERIES

**Fig.1 - Peak Pulse Power Rating Curve**

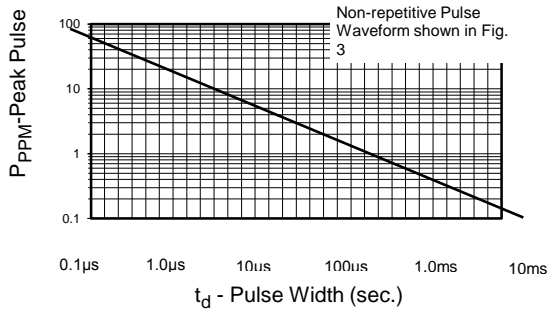

**Fig.2 - Pulse Derating Curve**

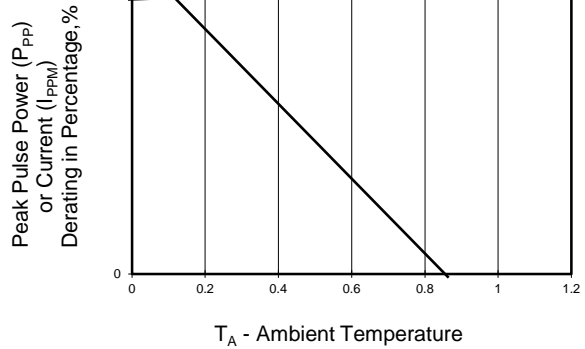

**Fig.3 - Pulse Waveform**

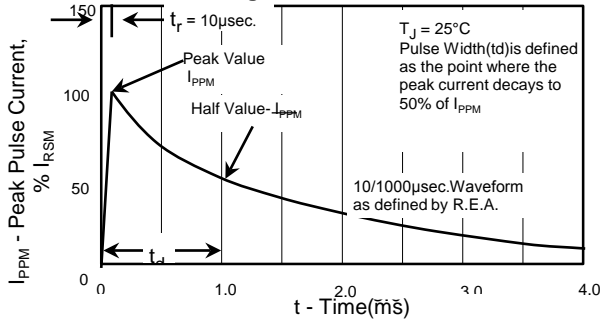

**Fig.4 - Typ. Junction Capacitance Uni-**

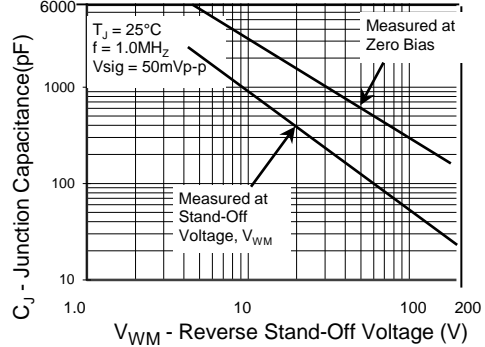

**Fig.5 - steady State Power Derating Curve**

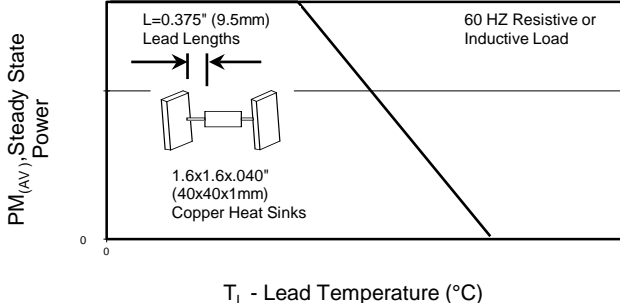

**Fig.6 - Max. Non-Repetitive Forward Surge**

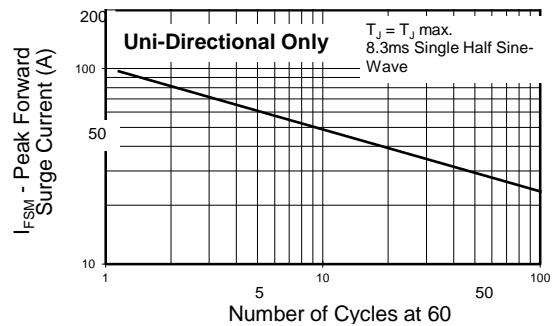

**Fig.7 - Typical Reverse Leakage Characteristics**

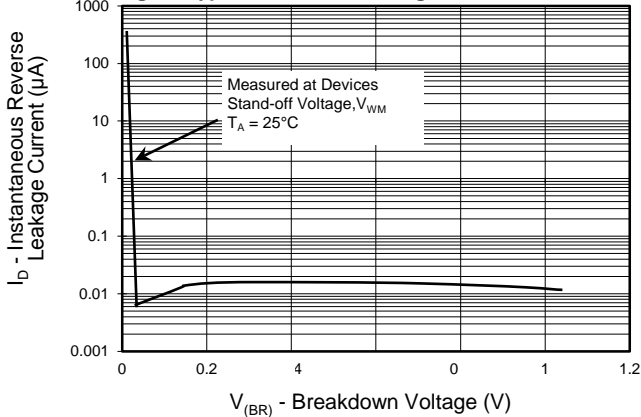

**Fig.8 - Typ. Transient Thermal Impedance**

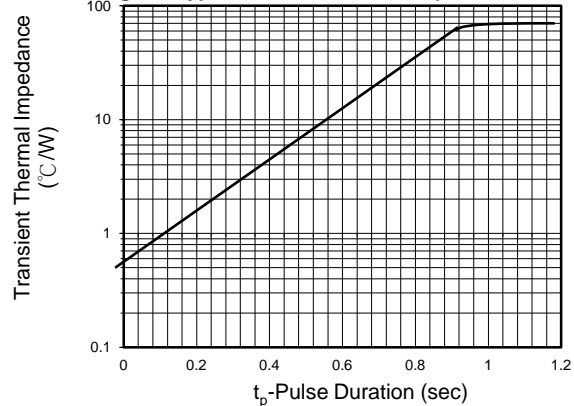

# MDE Semiconductor, Inc.

201 Shipyard Way, Unit C, Newport Beach, CA., USA 92663 Tel : 760-564-8656 • Fax : 760-564-2414  
1-800-831-4881 Email: sales@mdesemiconductor.com Web: www.mdesemiconductor.com

## 600 Watt TVS

UNI-POLAR	BI-POLAR	REVERSE STANDOFF VOLTAGE V <sub>RWM</sub> (V)	BREAKDOWN VOLTAGE V <sub>BR</sub> (V) MIN. @ I <sub>T</sub>	BREAKDOWN VOLTAGE V <sub>BR</sub> (V) MAX. @ I <sub>T</sub>	TEST CURRENT (I <sub>T</sub> ) mA	MAXIMUM CLAMPING VOLTAGE @I <sub>PP</sub> V <sub>C</sub> (V)	PEAK PULSE CURRENT I <sub>PP</sub> (A)	REVERSE LEAKAGE @ V <sub>RWM</sub> I <sub>R</sub> (μA)
P6KE6.8A	P6KE6.8CA	5.80	6.45	7.14	10	10.5	58.1	1000
P6KE7.5A	P6KE7.5CA	6.40	7.13	7.88	10	11.3	54.0	500
P6KE8.2A	P6KE8.2CA	7.02	7.79	8.61	10	12.1	50.4	200
P6KE9.1A	P6KE9.1CA	7.78	8.65	9.55	10	13.4	45.5	50
P6KE10A	P6KE10CA	8.55	9.50	10.50	1	14.5	42.1	10
P6KE11A	P6KE11CA	9.40	10.50	11.60	1	15.6	39.1	5
P6KE12A	P6KE12CA	10.20	11.40	12.60	1	16.7	36.5	5
P6KE13A	P6KE13CA	11.10	12.40	13.70	1	18.2	33.5	5
P6KE15A	P6KE15CA	10.00	14.30	15.80	1	21.2	28.8	5
P6KE16A	P6KE16CA	12.90	15.20	16.80	1	22.5	27.1	5
P6KE18A	P6KE18CA	14.50	17.10	18.90	1	25.2	24.2	5
P6KE20A	P6KE20CA	17.10	19.00	21.00	1	27.7	22.0	5
P6KE22A	P6KE22CA	18.80	20.90	23.10	1	30.6	19.9	5
P6KE24A	P6KE24CA	20.50	22.80	25.20	1	33.2	18.4	5
P6KE27A	P6KE27CA	23.10	25.70	28.40	1	37.5	16.3	5
P6KE30A	P6KE30CA	25.60	28.50	31.50	1	41.4	14.7	5
P6KE33A	P6KE33CA	28.20	31.40	34.70	1	45.7	13.3	5
P6KE36A	P6KE36CA	30.80	34.20	37.80	1	49.9	12.2	5
P6KE39A	P6KE39CA	33.30	37.10	41.00	1	53.9	11.3	5
P6KE43A	P6KE43CA	36.80	40.90	45.20	1	59.3	10.3	5
P6KE47A	P6KE47CA	40.20	44.70	49.40	1	64.8	9.4	5
P6KE51A	P6KE51CA	43.60	48.50	53.60	1	70.1	8.7	5
P6KE56A	P6KE56CA	47.80	53.20	58.80	1	77.0	7.9	5
P6KE62A	P6KE62CA	53.00	58.90	65.10	1	85.0	7.2	5
P6KE68A	P6KE68CA	58.10	64.60	71.40	1	92.0	6.6	5
P6KE75A	P6KE75CA	64.10	71.30	78.80	1	103.0	5.9	5
P6KE82A	P6KE82CA	70.10	77.90	86.10	1	113.0	5.4	5
P6KE91A	P6KE91CA	77.80	86.50	95.50	1	125.0	4.9	5
P6KE100A	P6KE100CA	85.50	95.00	105.00	1	137.0	4.5	5
P6KE110A	P6KE110CA	94.00	105.00	116.00	1	152.0	4.0	5
P6KE120A	P6KE120CA	102.00	114.00	126.00	1	165.0	3.7	5
P6KE130A	P6KE130CA	111.00	124.00	137.00	1	179.0	3.4	5
P6KE150A	P6KE150CA	128.00	143.00	158.00	1	207.0	2.9	5
P6KE160A	P6KE160CA	136.00	152.00	168.00	1	219.0	2.8	5
P6KE170A	P6KE170CA	145.00	162.00	179.00	1	234.0	2.6	5
P6KE180A	P6KE180CA	154.00	171.00	189.00	1	246.0	2.5	5
P6KE200A	P6KE200CA	171.00	190.00	210.00	1	274.0	2.2	5
P6KE220A	P6KE220CA	185.00	209.00	231.00	1	328.0	1.9	5
P6KE250A	P6KE250CA	214.00	237.00	263.00	1	344.0	1.8	5
P6KE300A	P6KE300CA	256.00	285.00	315.00	1	414.0	1.5	5
P6KE350A	P6KE350CA	300.00	333.00	368.00	1	482.0	1.3	5
P6KE400A	P6KE400CA	342.00	380.00	420.00	1	548.0	1.1	5
P6KE440A	P6KE440CA	376.00	418.00	462.00	1	602.0	1.0	5
P6KE480A	P6KE480CA	408.00	456.00	504.00	1	658.0	0.9	5
P6KE510A	P6KE510CA	434.00	485.00	535.00	1	698.0	0.9	5
P6KE530A	P6KE530CA	450.00	503.50	556.50	1	725.0	0.8	5
P6KE540A	P6KE540CA	459.00	513.00	567.00	1	740.0	0.8	5
P6KE550A	P6KE550CA	467.00	522.50	577.50	1	760.0	0.8	5

For bidirectional type having V<sub>rwm</sub> of 10 volts and less, the I<sub>R</sub> limit is double.

For parts without A, the V<sub>BR</sub> is ± 10%

Certified RoHS Compliant  
UL File # E223026