





# MDE Semiconductor, Inc.

## RATING AND CHARACTERISTIC CURVES 5.0SMDJ SERIES

**Fig. 1 - Peak Pulse Power Rating**

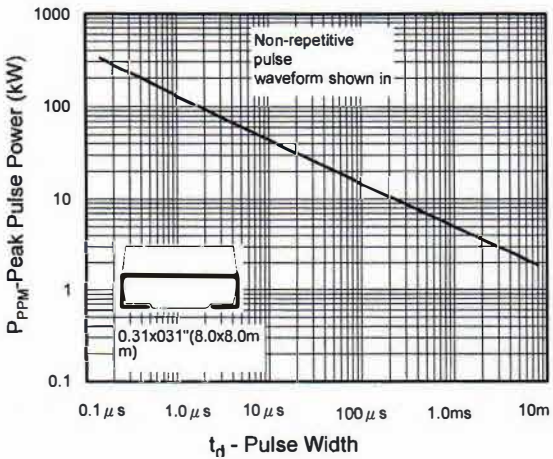

**Fig.2 - Pulse Derating**

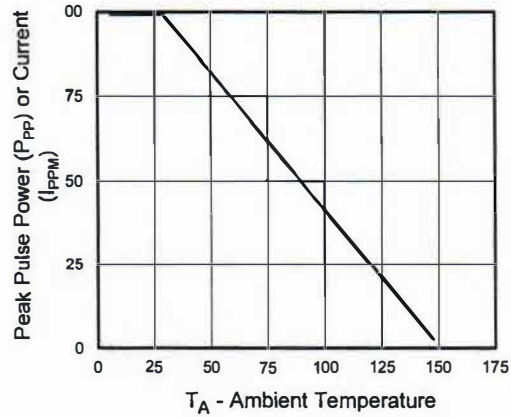

**Fig. 5 - Steady State Power Derating**

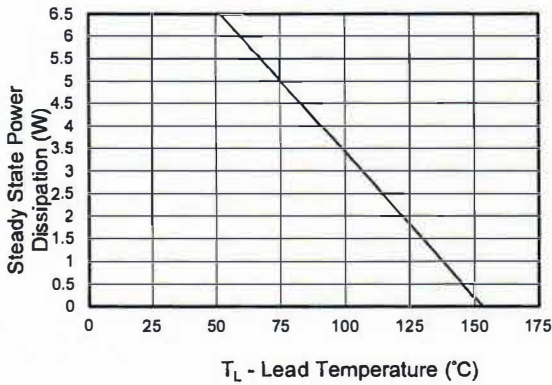

**Fig.6 - Maximum Non-repetitive Forward**

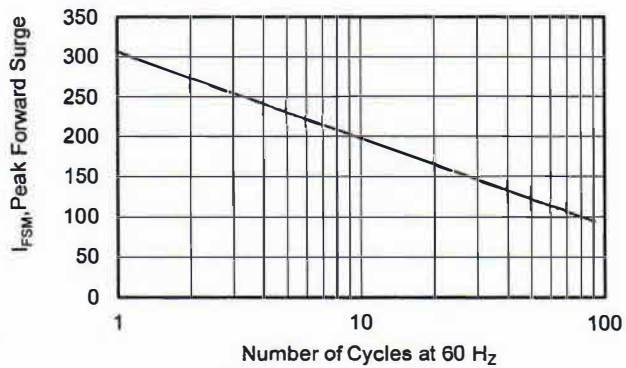

**Fig.3 - Pulse Waveform**

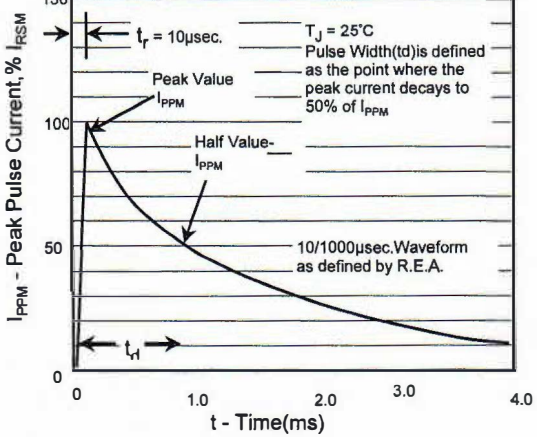

**Fig. 4 - Typical Junction Capacitance**

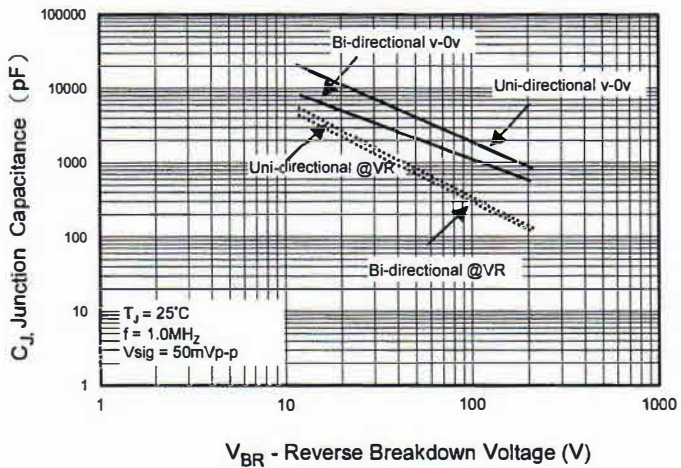

# **MDE Semiconductor, Inc.**

201 Shipyard Way, Unit C, Newport Beach, CA., USA 92663 Tel : 760-564-8656 • Fax : 760-564-2414  
1-800-831-4881 Email: sales@mdesemiconductor.com Web: www.mdesemiconductor.com

## **5.0 SMDJ SERIES SURFACE MOUNT TRANSIENT VOLTAGE SUPPRESSOR VOLTAGE-12.0 TO 15.0 Volts 5000 Watt Peak Pulse Power**

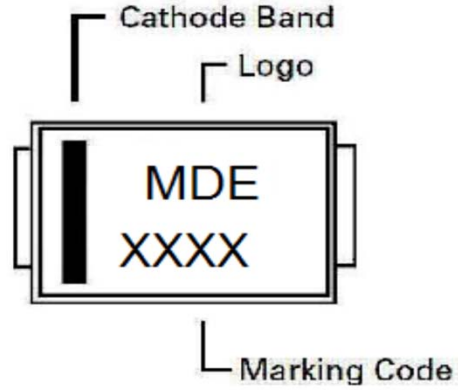
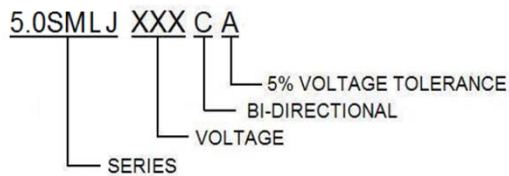

Part number	Component Package	Quantity	Packaging Option	Packaging Specification
5.0SMDJxxxXX	DO-214AB	3000	Tape & Reel - 16mm/13" tape	EIA STD RS-481
5.0SMDJxxxXX	DO-214AB	500	Tape & Reel - 16mm/ 7" tape	EIA STD RS-481